

Data Sheet



Article number: 2303141311

Description: E+G Adjustable handle w/threaded stud
MRX.40 p-M6x16

Measures

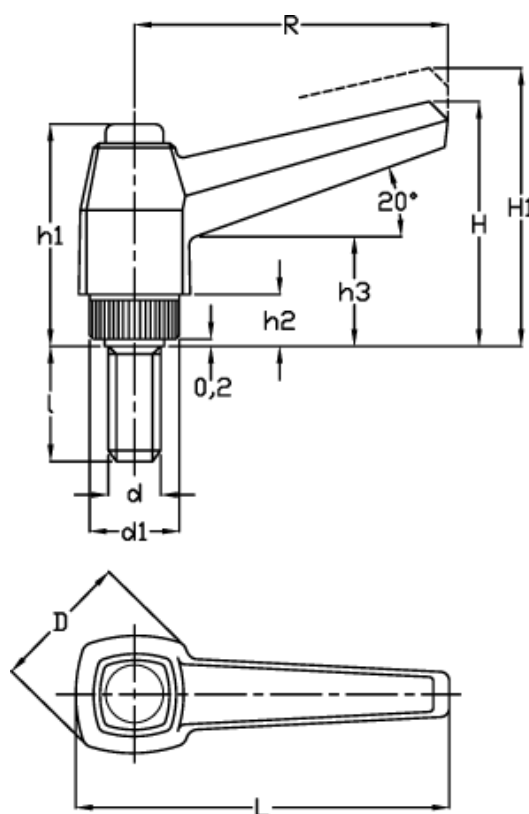

D = 18	I = 16
d1 = 12	L = 50
d 6g = M6	Number of teeth = 18
H = 32	R = 42
h1 = 29	
H1 = 35.5	
h2 = 6	
h3 = 14	